

Technical sheet :

KLEOS HM 500 D25

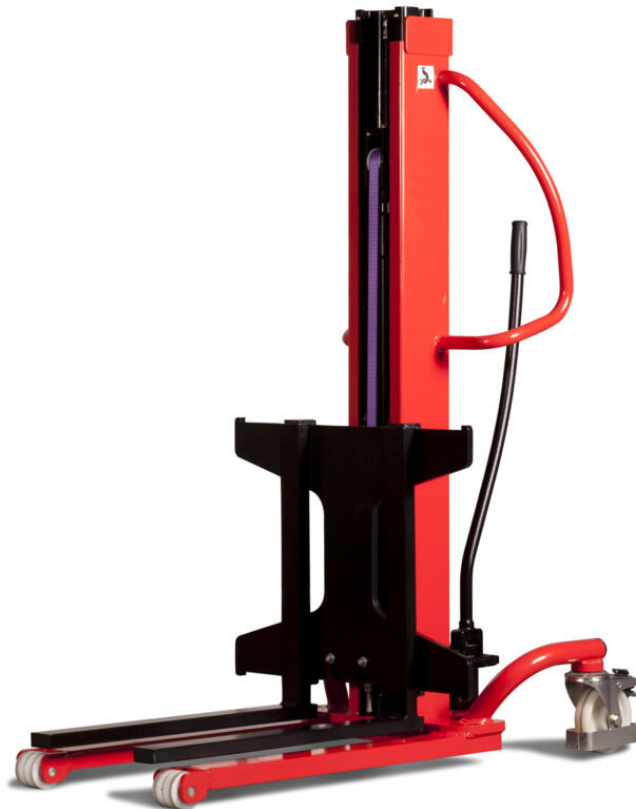

	Technical characteristics		Metric
1.1	Manufacturer		Manitou
1.2	Model Name		HM 500 D25
1.3	Power source		Manual
1.4	Operator type		Pedestrian
1.5	Max. capacity	Q	500 kg
	Weight		
2.1	Overall weight without tools		190 kg
	Wheels		
3.1	Tyres type		Nylon
3.2	Dimensions of front wheels		2x (75x65)
3.3	Dimensions of rear wheels		2x (150x50)
	Dimensions		
4.2	Height mast lowered *	h1	1950 mm
4.4	Max. lifting height	h3	2500 mm
4.5	Height mast extended *	h4	2480 mm
4.19	Overall length without tools	l1	1300 mm
4.20	Length to face of forks	l2	575 mm
4.21	Overall width	b1	710 mm
4.25	Fork spread	b5	519 mm
4.32	Ground clearance at centre of wheelbase	m2	35 mm
	Performances		
5.2	Lifting speed (laden / unladen)		0.10 m/s / 0.10 m/s
5.3	Lowering speed (laden / unladen)		0.10 m/s / 0.10 m/s
5.11	Parking brake		Mecanic

Kleos HM 500 D25 - Dimensional drawing

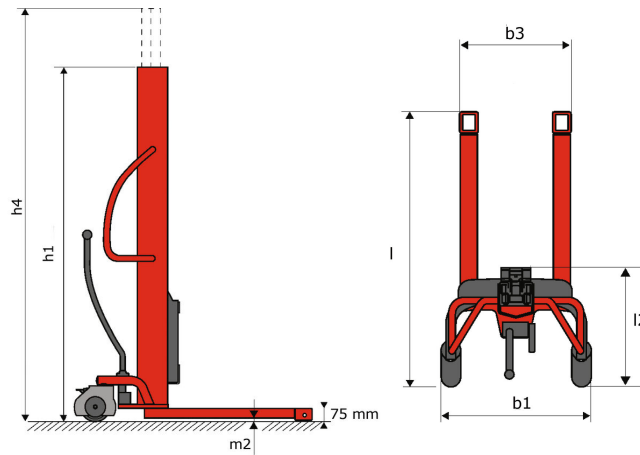

Tool characteristics

Tool 500 kg	Attachment capacity kg	Center of gravity of load	A1	A2	B	B1	C	D	E	E1	E2	F	Weight kg
			mm	mm	mm	mm	mm	mm	mm	mm	mm	mm	
EPE 500	500	-	700	715	50	-	252	-	-	-	-	320	30
FA 500	500	-	700	745	-	250	680	45	60	30	-	720	54
FR 500	500	-	1150	1177	560	200	315	85	-	70	-	700	68
FUT 500	300	-	795	650	1057	350	650	245	-	240	631	-	92
PLF 500	500	-	700	727	600	-	280	-	91	-	-	630	50
POT 500	250	-	625	652	50	-	150	-	-	-	-	320	25

Tools

EPE: Boom

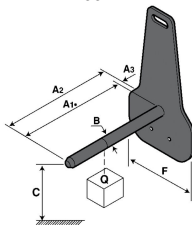

FR: Wrapover forks

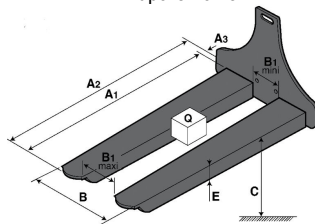

FUT: Drum handler

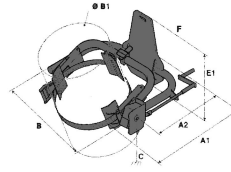

PLF: Fixed platform with drawer

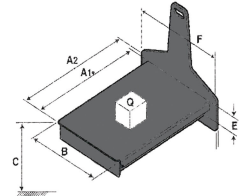

FA: Adjustable forks

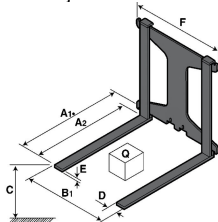

POT: Jib with hook

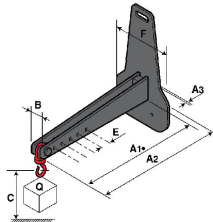



Siège Social

430 rue de l'Aubinière - 44150 Ancenis Cedex - France

Tel: +33(0)2 40 09 10 11 - Fax: +33 (0)2 40 09 10 97

www.manitou.com



This brochure describes versions and configuration options for Manitou products which may be fitted with different equipment. The equipment described in this brochure may be standard, optional or not available depending on version. Manitou reserves the right to change the specifications shown and described at any time and without prior warning. The manufacturer is not liable for the specifications given. For more information, contact your Manitou dealer. Non-contractual document. Product descriptions may differ from actual products. List of specifications is not comprehensive. The logos and visual identity of the company are the property of Manitou and may not be used without authorisation. All rights reserved. The photos and diagrams contained in this brochure are provided for information only.

MANITOU BF SA - Limited company with board of directors - Share capital: 39,668,399 euros - 857 802 508 RCS Nantes