

Technical sheet :

TMM 20 ST5



	Technical characteristics		Metric
1.1	Manufacturer		MANITOU
1.2	Model Name		TMM 20 ST5
1.2.1	Reach out equipment		Pantograph
1.3	Power source		Diesel
1.4	Operator type		Seated
1.5	Max. capacity	Q	2000 kg
1.6	Load centre of gravity	c	500 mm
1.8	Load distance, centre of drive axle to fork	x	500 mm
1.9	Wheelbase	y	1598 mm
	Weight		
2.1	Service weight		2290 kg
2.2	Weight on front axle (laden) / rear axle (laden)		3050 kg / 1240 kg
2.3	Weight on front axle (Unladen) / rear axle (Unladen)		1050 kg / 1240 kg
	Wheels		
3.1	Tyres type		Pneumatic
3.2	Dimensions of front wheels		23x9-10 IC30
3.3	Dimensions of rear wheels		23x9-10 IC30
3.5	Number of front wheels / rear wheels		2 / 1
3.5.2	Drive wheels (front / rear)		2 / 1
3.6	Front wheel gauge	b10	2103 mm
	Dimensions		
4.7	Height of overhead guard (cabin)	h6	2080 mm
4.8	Seat height/stand height	h7	1030 mm
4.19	Overall length	l1	2598 mm
4.21	Overall width	b1	2323 mm
4.22	Forks section / width / length	s / e / l	40 mm x 122 mm / 1200 mm
4.23	Fork carriage ISO 2328 (class/form) A/B		2A
4.24	Fork carriage width	b3	1260 mm
4.25	Distance between support arms	b5	1165 mm
4.26	Distance between wheel arms/loading surfaces	b4	1600 mm
4.28	Maximum horizontal extension at COG 600	l4	1000 mm
4.28	Max. outreach	r1	1005 mm
4.32	Ground clearance at centre of wheelbase	m2	231 mm
4.37	Overall length (without forks)	l7	1398 mm
4.34	Aisle width for 800 x 1200 pallet lengthways	Ast	3363 mm
4.35	Turning radius	Wa	2463 mm
4.36	Internal turning radius (over tyres)	b13	672 mm
	Performances		
5.1	Travel speed (laden / unladen)		9.40 km/h / 9.50 km/h
5.2	Lifting speed (laden / unladen)		0.26 m/s / 0.24 m/s
5.3	Lowering speed (laden / unladen)		0.38 m/s / 0.24 m/s
5.7	Gradeability (laden / unladen)		56 % / 51 %
5.10	Service brake		Hydraulic brakes by loss of pressure
5.9	Acceleration time (laden / unladen)		4.10 s / 2.60 s
5.11	Transmission type		Hydrostatic
	Engine		
7.1	Engine brand / nom		Kubota - Stage V
7.2	Engine power according to ISO 1585		18.50 kW
7.3	Rated speed		3000 rpm
7.4	Number of cylinders / Capacity of cylinders		3 - 1123 cm³
8.1	Type of drive control		Cable
7.5	Fuel consumption according to VDI cycle		3.40 l/h
	Miscellaneous		
8.2	Working hydraulic pressure for attachments		190 bar
8.3	Oil flow rate for attachments		43 l/min
8.4	Sound level at the driver's ear according to DIN 12 053		86 dB(A)

TMM 20 ST5 - Dimensional drawing

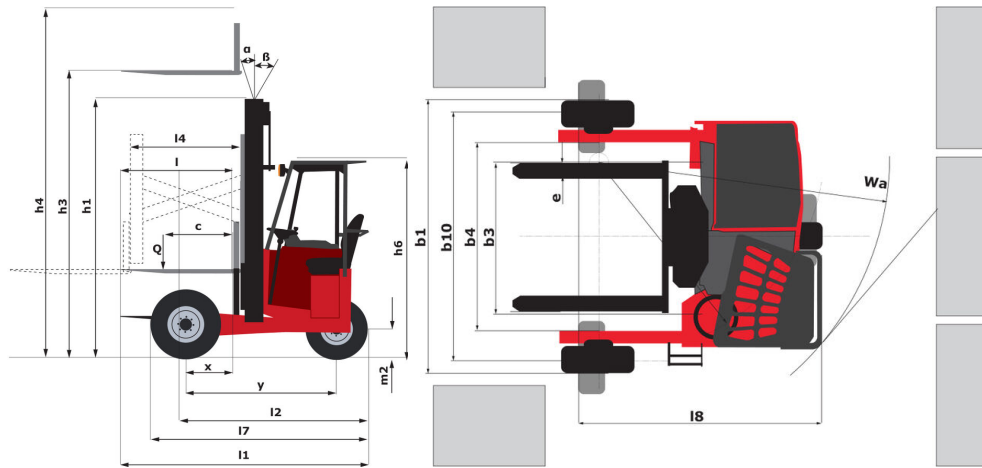

Characteristics of masts and residual capacities

		Full Visibility Duplex				
		FVD 30	FVD 36	FVD 39		
Capacity (Maximum Height & LC =)	Simple Reach	h1 - Height mast lowered *	mm	2352	2702	2852
		h3 - Lifting Height	mm	3000	3600	3900
		h4 - Height mast extended *	mm	4455	5055	5355
	Double Reach	Pantograph reach in	kg	2000	2000	2000
		Pantograph reach out with stabilizers	kg	1750	1750	1750
		Pantograph reach out without stabilizers	kg	1050	1050	1050
		Telescopic forks reach in	kg	2000	2000	2000
		Telescopic Forks reach out with stabilizers	kg	1300	1300	1300
		Telescopic Forks reach out without stabilizers	kg	1100	1150	1100
		Pantograph & TF reach in	kg	2000	2000	2000
		Pantograph & TF reach out with stabilizers	kg	1100	1100	1100
		Pantograph & TF reach out without stabilizers	kg	550	550	550



Siège Social

430 rue de l'Aubinière - 44150 Ancenis Cedex - France

Tel: +33(0)2 40 09 10 11 - Fax: +33 (0)2 40 09 10 97

www.manitou.com



This brochure describes versions and configuration options for Manitou products which may be fitted with different equipment. The equipment described in this brochure may be standard, optional or not available depending on version. Manitou reserves the right to change the specifications shown and described at any time and without prior warning. The manufacturer is not liable for the specifications given. For more information, contact your Manitou dealer. Non-contractual document. Product descriptions may differ from actual products. List of specifications is not comprehensive. The logos and visual identity of the company are the property of Manitou and may not be used without authorisation. All rights reserved. The photos and diagrams contained in this brochure are provided for information only.

MANITOU BF SA - Limited company with board of directors - Share capital: 39,668,399 euros - 857 802 508 RCS Nantes