

Technical sheet :

KLEOS HM 250 D18

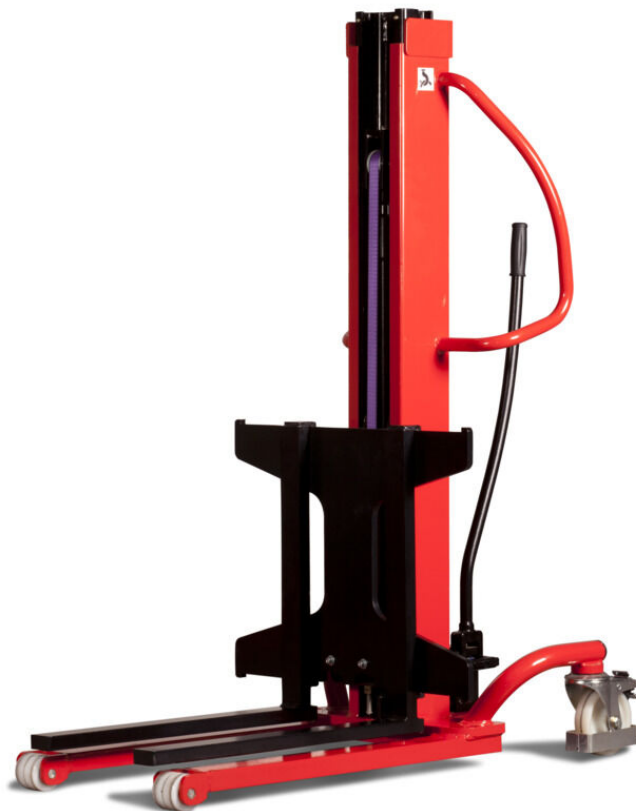

	Technical characteristics		Metric
1.1	Manufacturer		Manitou
1.2	Model Name		HM 250 D18
1.3	Power source		Manual
1.4	Operator type		Pedestrian
1.5	Max. capacity	Q	250 kg
	Weight		
2.1	Overall weight without tools		110 kg
	Wheels		
3.1	Tyres type		Nylon
3.2	Dimensions of front wheels		2x (75x65)
3.3	Dimensions of rear wheels		2x (150x50)
	Dimensions		
4.2	Height mast lowered *	h1	1585 mm
4.4	Max. lifting height	h3	1780 mm
4.5	Height mast extended *	h4	2475 mm
4.19	Overall length without tools	l1	1032 mm
4.20	Length to face of forks	l2	571 mm
4.21	Overall width	b1	710 mm
4.25	Fork spread	b5	529 mm
	Performances		
5.2	Lifting speed (laden / unladen)		0.10 m/s / 0.10 m/s
5.3	Lowering speed (laden / unladen)		0.10 m/s / 0.10 m/s
5.11	Parking brake		Mecanic

Kleos HM 250 D18 - Dimensional drawing

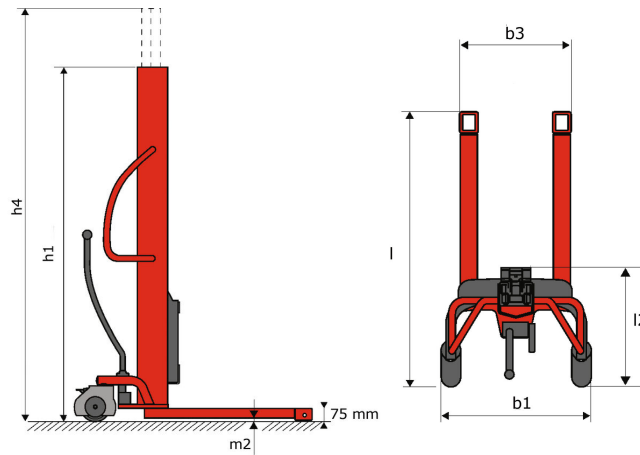

Tool characteristics

Tool 250 kg	Attachment capacity kg	Center of gravity of load	A1	A2	B	B1	C	D	E	E1	E2	F	Weight kg
			mm	mm	mm	mm	mm	mm	mm	mm	mm	mm	
EPE 250	250	-	500	515	40	-	270	-	-	-	-	320	21
FA 250	250	-	500	540	-	230	650	50	50	20	-	680	33
PLF 250	200	-	620	635	500	-	280	-	88	-	-	630	40
POT 250	150	-	425	440	50	-	170	-	-	-	-	320	22

Tools

EPE: Boom

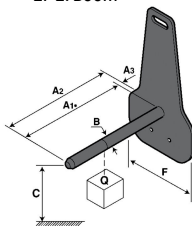

FR: Wrapover forks

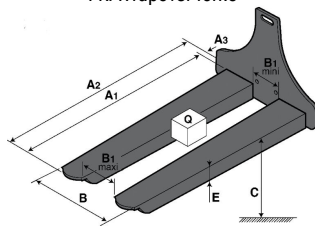

FUT: Drum handler

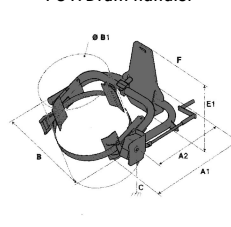

PLF: Fixed platform with drawer

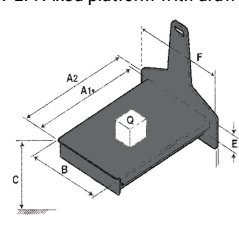

FA: Adjustable forks

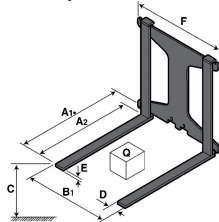

POT: Jib with hook

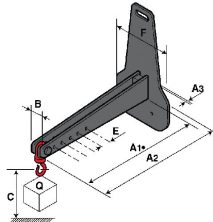



Siège Social

430 rue de l'Aubinière - 44150 Ancenis Cedex - France

Tel: +33(0)2 40 09 10 11 - Fax: +33 (0)2 40 09 10 97

www.manitou.com



This brochure describes versions and configuration options for Manitou products which may be fitted with different equipment. The equipment described in this brochure may be standard, optional or not available depending on version. Manitou reserves the right to change the specifications shown and described at any time and without prior warning. The manufacturer is not liable for the specifications given. For more information, contact your Manitou dealer. Non-contractual document. Product descriptions may differ from actual products. List of specifications is not comprehensive. The logos and visual identity of the company are the property of Manitou and may not be used without authorisation. All rights reserved. The photos and diagrams contained in this brochure are provided for information only.

MANITOU BF SA - Limited company with board of directors - Share capital: 39,668,399 euros - 857 802 508 RCS Nantes